



Beddgelert



Owners Handbook
For the Beddgelert 0-6-4 Locomotive

Operating Instructions

IMPORTANT: Read these instructions carefully before operating the locomotive

The following items are required for running this engine and are not included with the model.

Fuel Butane gas. See 'Gas System' section.

Water See 'Filling the boiler' section.

General Lubricating oil See 'Lubrication' section.

SAFETY PRECAUTIONS

This is a working model locomotive using steam under pressure and highly flammable fuel. Provided it is operated with reasonable care and attention, no problems should arise.

It is intended for use out of doors and must only be operated in a well-ventilated area.

Whilst the locomotive is in use, hot gasses are exhausted up the chimney and excess steam frequently blows off through the safety valve even when stationary, so operator and spectators should not bend over the model.

As you will appreciate, this is not a toy and is therefore unsuitable for young unsupervised children.

Follow manufacturer's recommendations regarding the safe storage of Butane gas canisters.

Some areas of the model will get quite hot whilst it is operating, so a pair of gloves is provided in the tool kit for your protection.

Always have to hand either a fire extinguisher or wet cloth when operating the model.

Beddgelert Instruction Manual



CONTENTS

Tool kit	Page 4
Running in	Page 4
Access to controls	Page 4
Identification of parts of the locomotive	Page 5
Preparing for operation	Page 6
1. Filling the Gas Tank	Page 6
2. Filling the Boiler	Page 7
3. Lubrication	Page 9
4. Lighting the Burner	Page 10
Running the locomotive	Page 11
Driving the Locomotive Manually	Page 12
Batteries	Page 13
Radio Control System	Page 13
Water top-up system	Page 15
Trouble shooting & maintenance	Page 16
Storage between operating sessions	Page 16
Steam leaks	Page 17
Water top-up system	Page 17
Regulator not shutting	Page 17
Radio control	Page 18
Gas system	Page 18
Gas Jet Removal	Page 19
Boiler and Gas Tank Certificate, (<i>EC Declaration Of Conformity</i>).	Pages 21 & 22

TOOL KIT

The following items are included with your locomotive.

One 60ml bottle of special steam oil for use in the lubricator.

One 60ml syringe with plastic tube for filling the boiler with water.

One water top up pump bottle.

One set of spare washers and 'O' rings.

One spare gas jet.

One gas Filling adapter

One pair of protective gloves.

One cleaning duster.

One Allen key for cylinder socket cap screws.

RUNNING IN

All locomotives are test run before leaving the factory, but when new, will require several hours of running in to overcome initial tightness and allow valves etc. to 'bed in' completely. Also, the loco will waste a proportion of it's water and steam until 'run in' due to leaking slide valves, a tendency to prime more, and simply overcoming the initial tightness of the moving parts. As the model heats up and cools down each time you raise steam, screws and nuts have a tendency to stretch and loosen a little, which means that you will need to make regular checks and 'nip up' any that become loose. Most are quite visible and easy to get to. However, if there is any steam leaking from the valve chests between the frames, contact the factory for further information.

ACCESS TO THE CONTROLS

For normal operation, all main controls are accessible without the need to remove any part of the locomotive; however, for ease of servicing, the cab roof can be removed by sliding backwards, and then lifting off.

The gas regulator is located in the right hand side of the cab doorway, and is accessible without removing the roof.

The displacement lubricator is positioned inside the cab, at the front left hand side. The lubricator drain screw is positioned underneath the cab floor on the left side.

IDENTIFICATION OF LOCOMOTIVE MAIN CONTROLS

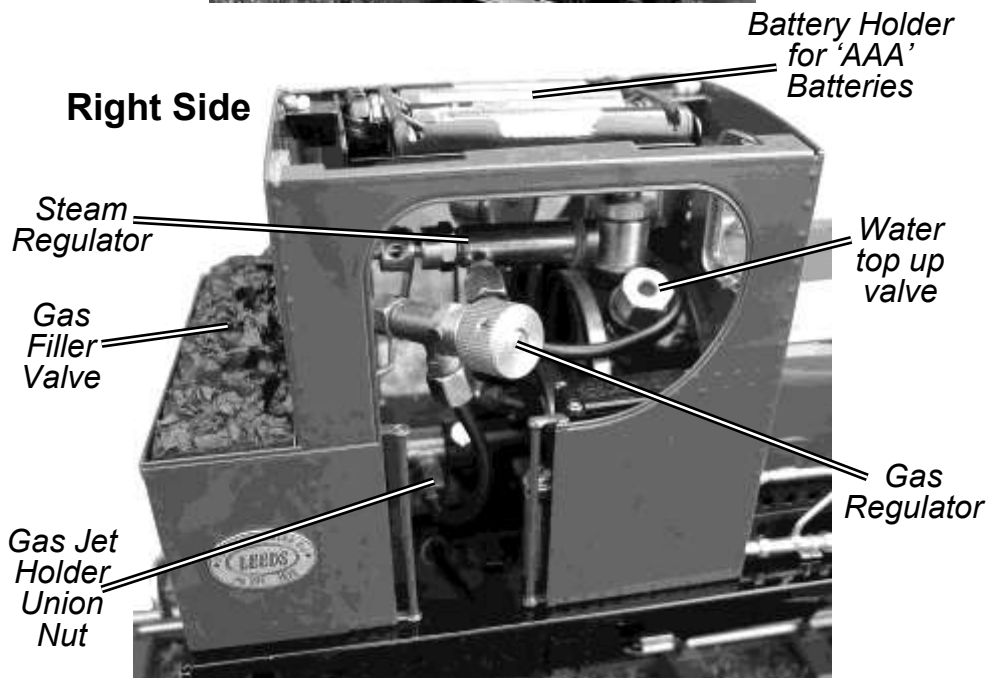
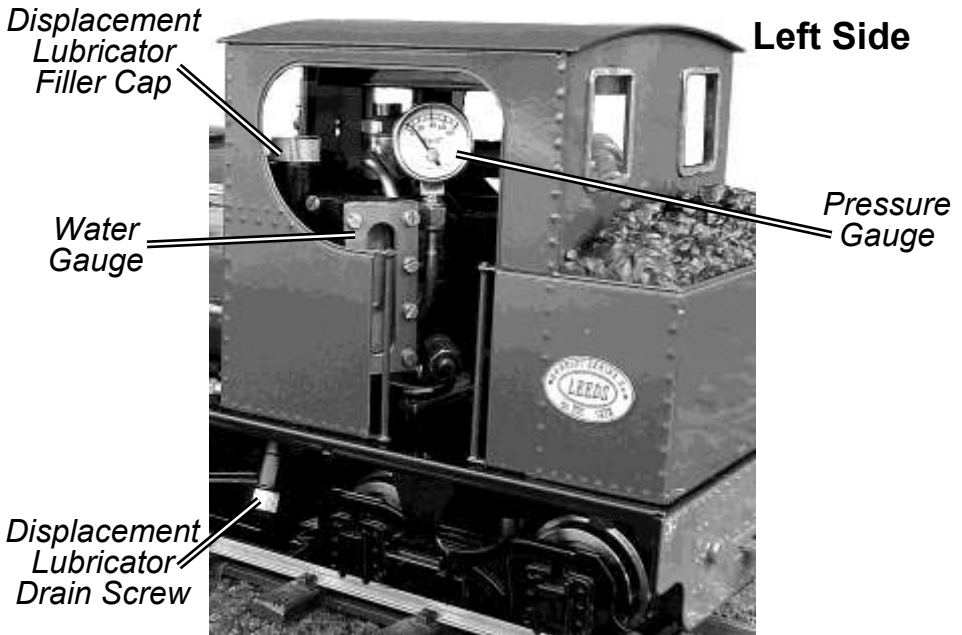

The gas filler valve and gas tank are situated in the rear bunker, underneath a dummy coal load. There is a hole in the Dummy coal load to allow access to the Gas Filler Valve. Please note that the coal load is fixed in position and cannot be removed.

The switch for the locomotive R/C equipment is on the left hand side, underneath the cab floor, at the rear of the locomotive.

The radio control equipment fitted to the locomotive is powered by 4 x AAA batteries. The battery box is accessed by removing the roof by sliding it to the rear, and then lifting off.

PREPARING FOR OPERATION

The locomotive must be serviced before being operated. It is important to perform all the following operations.

NOTE, check that the batteries in both the R/C transmitter and the locomotive are in good condition before attempting to operate the model - see the Radio Control section later on.

1) FILLING THE GAS TANK

The filling of the gas tank should only be carried out in a well-ventilated area, where there are no naked lights or other lighted locomotives close by. Ordinary Butane or Iso-butane gas (as used in gas cigarette lighters) is the preferred fuel, though for economy, the larger canisters as used for blowlamps or camping stoves etc. are better. The larger canisters have an EN417 threaded self sealing valve on top and require a special adapter to couple up to the filler valve on the locomotive. A Gas Filler Adapter is obtainable from your local garden railway supplier or direct from ROUNDHOUSE. Mixed gasses are also available and may be used if ordinary butane or iso-butane are not available, but see the 'Gas System' section for more information on this subject.

Before attempting to fill the gas tank, make sure that the gas control valve is closed by turning it clockwise and that there are no other operating locomotives or naked flames nearby.

The filler valve for the gas tank is in the rear bunker and is

accessed through a hole in the dummy coal load. Ensure that the gas canister is fitted with a correct adapter, then invert it and place its nozzle over the gas filler valve. Support the locomotive from underneath in the area of the tank, and press the canister down. The gas will be heard hissing as it enters the tank and a small amount will escape around the valve. This is quite normal and is the tank venting as the liquid enters. After about 20 to 30 seconds liquid gas will emerge from the valve showing that the tank is full. Remove the canister immediately. Filling times will vary depending on the temperature of the locomotive and are for guidance only.

2) FILLING THE BOILER

There are two methods of filling the boiler

1/ Quick filling when cold.

The Brass Dome in the centre of the saddle tank can be lifted off to allow access to the safety valve. This can simply be unscrewed and the boiler filled using the syringe and tube provided.

This dome is substantial and heavy item, being machined from solid brass. Take care not to drop it onto the locomotive, as the weight of it may damage the model. Care is especially needed if the locomotive is, or has been in steam, as the dome will be hot and will retain its heat for a considerable time.

Remove the safety valve and using the 60 ml syringe and plastic tube supplied, fill the boiler right to the top with clean water. Distilled water is recommended if available. As an alternative to distilled water if this is unavailable, clean tap water can be used in soft water areas. Also, rain water or water from a dehumidifier can be used provided that it is adequately filtered. Many people now use rain water passed through a coffee or wine making filter to remove any particles or debris in the water.

Do not use deionised water as this may cause long term damage to the boiler and fittings.

There has to be a space above the water to allow steam to be

Safety Valve located under Dome.

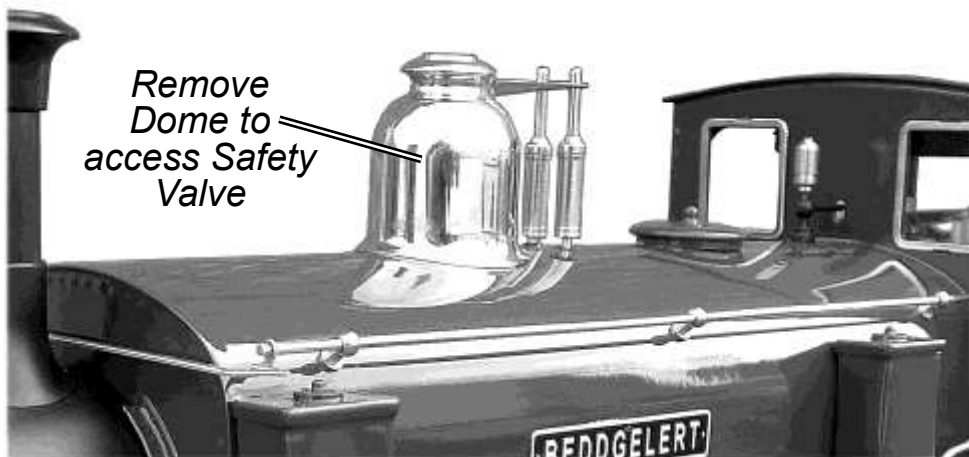

raised so, insert the end of the plastic pipe into the boiler and withdraw 30 ml of water with the syringe. Replace the filler plug finger tight, and then place the dome back over it. Note that there is a rubber 'O' ring around the body of each filler plug. This is to retain the domes during normal operation.

2/ Pump bottle when hot or cold.

In the Right Hand side of the cab is a top-up-valve. Fill the plastic pump bottle with clean water and push the end of the plastic tube into the socket in the top up valve.

The socket has a slight taper in it, and a little downward pressure on the tube will ensure a good seal.

Pump the handle on the bottle to inject water into the boiler whilst maintaining this downward pressure. Keep pumping until the water level in the water gauge is almost at the top of the glass.

Remove the plastic tube. Note that a small amount of water will remain in the top of the valve but will evaporate away as the valve heats up. Replace the roof.

3) LUBRICATION

Regular lubrication of all working parts is important and should be carried out before each operating session. There are two types of lubrication required: The external moving linkages and bearings are lubricated with a medium oil such as motor engine oil, and the internal steam mechanisms such as cylinders, pistons and valves are lubricated with a special steam oil that is mixed with the steam. Infrequent external lubrication will allow parts to run dry, and over oiling can form pools around operating parts that attract dirt and grit. If too thin an oil is used it will evaporate very quickly as the loco gets hot – leading to dry running. We recommend the use of a 20-50 motor oil for external lubrication. When carrying out general lubrication, do not forget the regulator spindles (see Trouble Shooting section for further details of oiling the regulators).

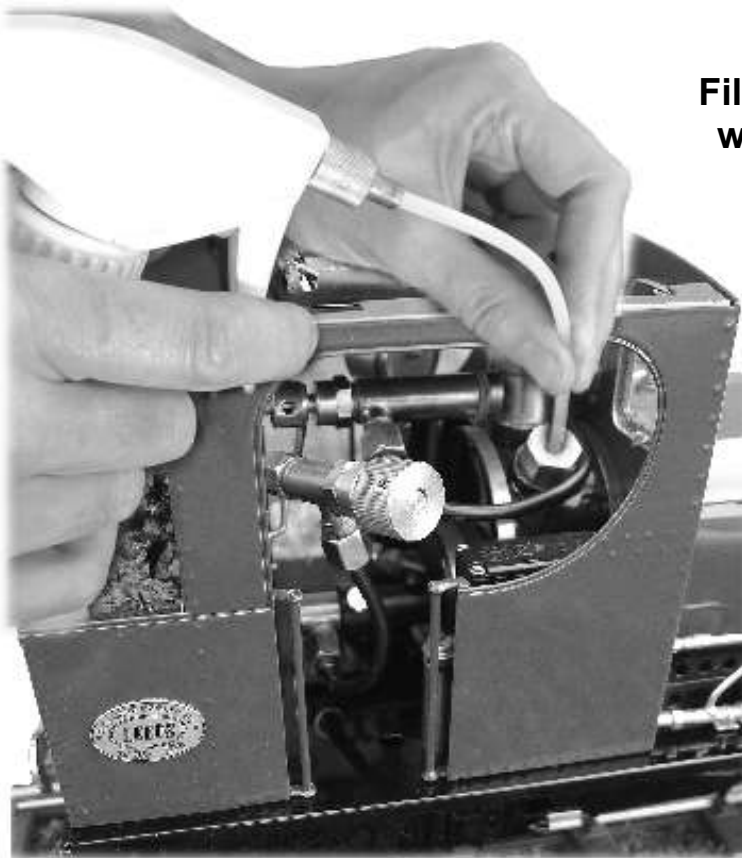

**Filling Boiler
with Pump
Bottle**

Internal lubrication is achieved by steam oil that is mixed with the steam in the displacement lubricator, housed in the front, left-hand side of the cab. Unscrew and remove the knurled cap from the top of the lubricator. Locate the knurled lubricator drain screw located under the cab floor. Unscrew this two or three turns, but do not remove it. Any water in the lubricator will run out through the hole in the drain screw. When the water has finished draining, tighten the drain screw and refill the lubricator from the top with the steam oil supplied. Replace the cap. Take time filling the lubricator, especially when cold, as the oil takes time to run down and may trap an air bubble. Both cap and drain screw are fitted with 'O' rings and need only be closed finger tight.

NOTE: Only special steam oil as supplied should be used in the lubricator and under no circumstances should ordinary oil be substituted, or damage may result.

4) LIGHTING THE BURNER

WARNING: Before lighting read the section on the gas system in the Troubleshooting section later on and be aware of potential problems. If the gas system is not operating correctly, **shut it off immediately** or damage may result.

Move the locomotive to another location before lighting. Butane is heavier than air and small pockets of gas can collect around the locomotive during filling.

To light the burner, hold a lighted match or cigarette lighter over the top of the chimney and **slowly** open the gas regulator by turning it anti-clockwise. The gas should ignite almost immediately with a pop as the flame travels down the chimney and into the boiler tube. The burner should be audible but not too loud.

NOTE as stated above, the gas regulator should be opened slowly until the burner ignites. If opened too quickly or too far, particularly when the engine is cold or if the gas tank has just been filled, it is possible that the flame may not ignite correctly, or may not travel back into the boiler flue but stay in the smoke box. If this should

happen, the burner will sound quite different to normal and the blue flame will be visible in the smoke box if viewed down the chimney from a safe height. Should this happen, turn off the gas immediately or damage may result and then re-light it. If the problem persists and it is not possible to ignite the burner correctly, then a dirty jet should be suspected and cleaned as detailed in the Troubleshooting section.

For the first couple of minutes keep the burner on low. This is important, as until it warms up, the flame will be a little unstable and turning it up too much could cause it to go out. Also, with a completely full tank, liquid gas could be drawn off instead of vaporized gas, which can also extinguish the flame.

After a couple of minutes, the gas control valve can be opened more to speed up steam raising. Open the gas regulator slowly. The full range of adjustment (closed to fully open) is achieved within the **first half to three quarters of a turn** of the gas regulator knob any more is unnecessary.

RUNNING THE LOCOMOTIVE

When full working pressure has been reached (between 35 and 40psi), the safety valve will start to blow off steam. Steam generation can be controlled by the gas regulator valve in the right hand cab doorway. If the safety valve blows off frequently during running, then too much steam is being produced, which wastes water and gas. Turning down the burner will decrease the amount of steam created. Conversely, if steam pressure is not maintained during a run, then the burner should be turned up.

After a few minutes of running it may be noticed that the gas pressure through the burner has increased. This is due to the gas tank becoming warmer and so increasing the gas pressure. Simply turn the gas down – this may need to be performed several times during a run. The art of balancing steam generation to the operational requirement by the adjustment of the gas control valve will quickly be learned.

The standard gas tank has a duration of about 25 minutes, though

this will vary depending on the gas valve setting. The boiler should not be allowed to run dry, and the gas tank capacity is such that the gas should run out before the water but it is good practice to keep an eye on the water gauge as a check. When the gas is fully used up, the steam pressure in the boiler will be seen to gradually drop until the loco comes to a halt.

Should the water expire before the gas is fully used, the pressure will drop rapidly and the loco will stop. Check the pressure gauge and water gauge – if there is no steam pressure or visible water, turn off the gas. No damage will result if the gas is turned off immediately and the engine left to cool. Never add cold water to a hot, empty boiler in an attempt to cool it and never re-fill the gas tank without first checking the water level in the boiler.

Ensure that the gas valve is completely turned off before refilling the gas tank.

DRIVING THE LOCOMOTIVE MANUALLY

On manually controlled locomotives, there are three main controls, all of which are housed in the cab.

1) The Gas Regulator. This is used to control steam generation as described earlier.

2) The Reversing Lever. This is in the left-hand side of the cab and is moved fully forward for running in a forward direction and fully back to run in the reverse direction. It should be parked in the centre (mid gear) when the locomotive is stationary for any length of time. When in mid gear position, the valve gear is effectively in neutral and the engine will not move under steam power.

3) The Steam Regulator. This is the main steam control valve and regulates the speed of the locomotive. The regulator handle is situated in the right hand cab doorway and is moved anti-clockwise to open and clockwise to close.

Using the reversing lever, select the desired direction of travel and open the regulator a little. Initially, there will be a certain amount of water in the pipes and cylinders, which will exhaust through the chimney and, after a few moments, the engine will move jerkily, until this clears. Once the parts have warmed up, the engine will move off steadily and its speed can be controlled with the regulator. Subsequent starts will be quite smooth once the cylinders etc. have reached their normal operating temperature.

To reverse the locomotive, close the regulator to bring it to a halt, move the reversing lever over and open the regulator again.

The art of fine control will soon be learnt with a little practice.

BATTERIES

Batteries must be fitted to the locomotive before it can be run. To do this we need to remove the cab roof. The battery holder is positioned just underneath the cab roof, and batteries can be fitted without removing the battery holder. Refer to the instructions supplied with the Radio Control equipment as to the correct batteries required. Refit the roof.

RADIO CONTROL SYSTEM

This model is fitted with 2.4 GHz R/C equipment. On a Radio Controlled model, speed and direction are controlled by the transmitter. First, turn on the transmitter and then switch on the receiver on the locomotive. The left hand stick on the transmitter controls the steam regulator; down for stop and up for go. Moving to the left or right has no function.

The right hand stick operates the valve gear. Move the stick fully to the left for forward and fully to the right for reverse. This stick is sprung loaded to return to its central position. Moving up or down has no function

Using the transmitter, select the desired direction of travel and then slowly open the regulator. The locomotive will now move off as

described in the manual control section.

For more information on using the radio control equipment, see the manufacturer's instruction booklet supplied with the Radio Control Set.

The art of fine control will soon be learnt with a little practice

NOTE: Ensure that the valve gear is fully in gear for the required direction when the engine is moving. The model is fitted with a simplified Walschaerts type valve gear which is not suitable for 'notching up' (altering the cut off).

Always bring the locomotive to a halt by closing the regulator before changing direction. If an emergency stop is required, simply release the reversing lever, which will spring back into mid gear and halt the train. Then close the regulator. Always ensure that the regulator is fully closed before switching off the radio control equipment.

Always switch off the receiver and transmitter when not in use to preserve battery life. It is good practice to switch on the transmitter before the receiver and switch off the receiver before the transmitter. In this way, the radio receiver is never on when the transmitter is switched off and so should always be under your control.

When the batteries are getting low, a poor signal between transmitter and receiver will result and control of the engine will become erratic. Refer to the instructions supplied with the radio control equipment.

WATER TOP UP SYSTEM

A water top up system is fitted to this model. This enables the water level in the boiler to be monitored and topped up to keep the engine in steam for long periods.

Once the locomotive is in operation as detailed in the previous sections, water can be added to the boiler at any time during the run as follows.

Fill the water pump bottle from your usual water supply.

Bring the locomotive to a halt in a convenient place and remove the cab roof.

Push the end of the plastic tube down into the Water Top Up Valve, located in the Right Hand side of the cab. Whilst still holding the pipe in position and exerting slight downward pressure, pump the handle and this will inject water into the boiler.

You will sometimes see water and air bubbles passing through the sight glass as you pump so allow the level to settle after a few pumps. Carefully pull the plastic pipe out of the Water Top Up Valve whilst steadying the engine.

Sometimes, small particles of dirt will find their way in with the water and may cause the water filling valve to leak back a little when the pipe is removed. If this should happen, re-connect the pipe and give a further pump or two of water to clear it.

A small amount of water may remain in the socket of the filler valve once the plastic pipe has been removed and will boil off as the fittings return to normal operating temperature. This is quite normal.

Once you start running your loco you will see the water level in the gauge slowly dropping. Note that air bubbles may sometimes form in the gauge giving a false reading but these can be pushed out by connecting the pipe from the water pump to the water filling connector and injecting some water.

It is better to pump small amounts of water into the boiler at frequent intervals as this maintains a more even boiler pressure and prevents long waits while the cold water heats up and pressure returns to normal operating level.

Aim to keep the water level between $\frac{1}{2}$ and $\frac{3}{4}$ up the gauge and re-fill the gas tank as detailed earlier whenever it is empty. In this way, you can keep the loco in steam and at working pressure as long as you like.

Don't forget to re-fill the displacement lubricator about every 45 minutes.

TROUBLESHOOTING & MAINTENANCE

On a working model of this nature, it is important to keep all working parts well lubricated as detailed in the lubrication section.

With constant heating up, cooling down and the stresses of hard work, screws etc. can work loose so, it is good practice to check all fixings and cylinder screws regularly, particularly when the model is new but, remember - never over tighten.

STORAGE BETWEEN OPERATING SESSIONS

At the end of an operating session, it is good practice to clean the locomotive carefully with a clean soft cloth, and to oil all bright metal parts.

- * Do not leave fuel or water in the tank or boiler for long periods.
- * Do not store in places where the temperature may drop below freezing as water may still be present in the pipework.
- * Ensure all controls are closed and the valve gear in mid gear.
- * Ensure that radio control equipment is switched off.
- * Remove batteries from the locomotive and the transmitter.

Periodically it may be necessary to wash off all traces of dirt and old oil from the moving parts with paraffin (not thinners). This will remove any accumulations of dirt or grit. After washing with paraffin, leave to dry thoroughly overnight before re-oiling. It is most important that clean oil is applied and allowed to penetrate fully into all moving parts before the locomotive is run again. Manually moving the locomotive back and forth will assist in distributing the oil fully. Under normal operating conditions this procedure should not be required more than once or twice per

year.

STEAM LEAKS

The cylinders are fitted with 'O' rings in the glands sealing both piston and valve rods. These can be adjusted if steam leaks develop. They should only be tightened just enough to stop the leak, as over tightening will affect the running of the model. Cylinder covers are fitted with gaskets and valve chests with 'O' rings. A little 'bubbling' of oil may sometimes occur around these and is quite normal; however, steam leaking past the gasket should be attended to.

If 'nipping up' the retaining screws does not stop a steam leak, a service kit is available which includes replacement gaskets and seals and full instructions for fitting.

WATER TOP-UP SYSTEM

Over a period of time the end of the plastic filling tube that pushes in the boiler top-up valve will become a loose fit due to the heat of the fitting. To cure this, simply cut approximately 6mm from the end of the tube when necessary.

REGULATOR NOT SHUTTING (R/C models)

The steam regulator seating and seal can, after a period of time become worn or compressed so that when the lever on the radio control is fully closed, the locomotive still moves. To overcome this, a trimmer is fitted to the transmitter. As wear takes place in the regulator, it can gradually be adjusted to compensate. When no more adjustment is possible, it is time to reset the trimmer and adjust the linkage between the servo and the regulator in the cab. If adjustment does not cure this problem, the internal 'O' ring is probably damaged and requires replacement. Contact the factory for further advice.

Periodic oiling of the gland will help keep the regulator working freely. Place a spot of motor oil between the gland nut and the regulator arm and work the regulator a few times.

RADIO CONTROL

If the radio control gives problems, always check the batteries first and replace if in doubt.

For more information on using the radio control equipment, see the manufacturer's instruction booklet supplied with the Radio Control Set.

GAS SYSTEM

Internally fired locomotives are fitted with our 'FG' type gas burner, which is set up and fully tested at the factory.

This system is designed for use with Butane or Iso-Butane gas. Mixed gasses, i.e. Butane with a proportion of Propane mixed in, are available, and may be used if straight Butane is unavailable. These come in a variety of mixes ranging from 90/10 to 60/40 with one of the most common being 70/30. The figures refer to the proportions of the mix i.e. 70/30 contains 70% butane and 30% propane. If using mixed gasses, always choose the one with the largest proportion of butane. The addition of propane slightly alters the gasses properties. This can make the burner a little more difficult to light when cold or after filling the gas tank. Always open the regulator very slowly when lighting, and only just sufficient for ignition to take place. Opening too much too soon may extinguish the flame until the burner reaches normal operating temperature.

The tiny jet in these units can become blocked, or partially occluded by small particles of dirt making the burner difficult to light, burn weakly at normal operating temperatures*, burn in the smokebox or fail completely. (* On very cold days, a burner may start off burning weakly due to the temperature of the gas but should increase to its normal level as the engine warms up. This is quite normal).

If any of these should happen the Gas Jet will require cleaning or replacing.

GAS JET REMOVAL

To remove the gas jet, first remove the roof. Unscrew and remove the plastic battery holder. . Using a 2BA spanner, unscrew the Gas Jet Holder Union Nut. This connects the gas pipe to the gas regulator - see the photograph on Page 5. Loosen the gas jet holder retaining screw which will allow the gas jet holder to be pulled backwards and out. The Gas Jet can now be removed from the gas jet holder using a 4 BA spanner, and cleaned or replaced.

Note when connecting or disconnecting the gas pipe or gas jet holder, do not use excessive force. Wash out the jet in fast evaporating thinner (Cellulose or similar). Blow through the jet from the front, which should clear most blockages. Although the hole through the jet is tiny, if you hold it up to the light you should be able to see quite clearly if it is blocked or not. If in doubt, fit a new jet - a spare is included with the toolkit. Do not use wire to clean the jet as this can damage the precision hole and may upset the delicate balance of the gas system. Reassemble in the reverse order, putting a small amount of PTFE tape round the thread of the jet. Ensure all connections are tight. When re-positioning the gas jet holder in the burner, ensure that it is pushed in as far as it will go.

The gas regulator has a spindle 'O' ring housed inside the body which may need lubrication from time to time if the control becomes 'spongy' in operation, making precise gas control difficult.

As stated in the lighting instructions earlier, the full range of adjustment for normal burner operation is achieved within the first full rotation of the regulator knob, and it should only be unscrewed more than this for maintenance purposes and when the tank is empty, and there are no naked lights nearby.

To lubricate it, remove the knurled knob which is retained by a M3 socket grub screw (M 1.5 AF Allen key required) in the side.

Beneath the knob is a back-lash spring which will slide off the spindle.

Unscrew the hexagon retaining nut then screw the spindle out of the body.

The 'O' ring can now be lubricated.

Replace the spindle followed by the retaining nut. Slide the backlash spring over the spindle and replace the knob. Note that the grub screw that holds the knob in place tightens into a groove near the end of the spindle.

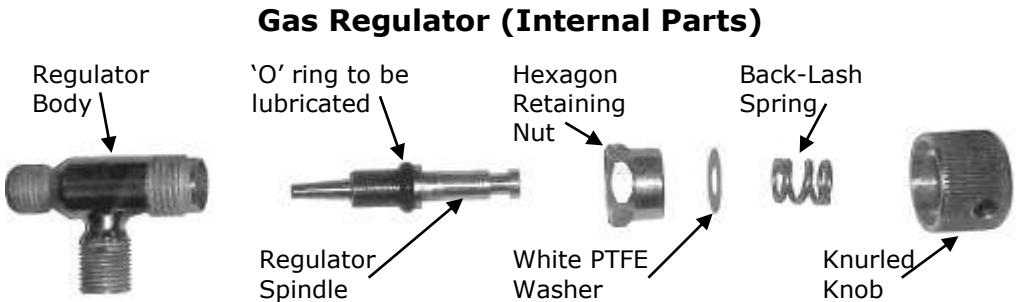

ROUNDHOUSE

ROUNDHOUSE
ENGINEERING
CO.

EC

De

Ste

am
Ge
ner

Ves-

Mo

sel for
Group
1 gas-
ses and
associ-
ated
pipe
work and

Si

R. Lo

Please refer to the 'owners handbook' for your particular model of locomotive, for details on correct use of these pressure vessels.

Pressure vessel care and maintenance

Gas tank

The gas tank is used for the storage of LPG (liquefied petroleum gas) in the form of butane, iso-butane or as set out in the 'owners handbook'.

The tank is fitted with a self-venting filler valve which contains no serviceable parts. Should the filler valve become defective in any way, it must be replaced with a new item.

It is recommended that the gas tank should undergo the following checks, carried out by a 'competent person', club, society or pressure vessel manufacturer, every year:-

1) thorough visual inspection.

And every five to ten years:-

1) hydrostatic pressure test to not less than 1.5 and not more than 2 times the maximum working pressure.

Boiler

The boiler is fitted with a safety valve to prevent the steam pressure rising above the maximum allowable working pressure. This is pre-set to open at between 2.38 bar (35 psi) and 2.72 bar (40 psi) and must not be adjusted to increase this value. If the safety valve becomes defective in any way, it should be replaced or returned to the factory for service and calibration.

It is recommended that the boiler should undergo the following checks, carried out by a 'competent person', club, society, or pressure vessel manufacturer, every one to two years:-

1) thorough visual inspection.

2) hydrostatic pressure test to not less than 1.5 and not more than 2 times the maximum working pressure.

3) steam test to check the correct functioning of all steam controls, gauge and safety valve.

Gas Burner

- 1). Superheater Pipe.
- 2). Lubricator Pipe.
- 3). Gas Jet Holder retaining screw.
- 4). Gas Jet.
- 5). Gas Jet Holder.
- 6). Gas Pipe.
- 7). Gas Burner fixing screw.
- 8). Air Inlet Holes.

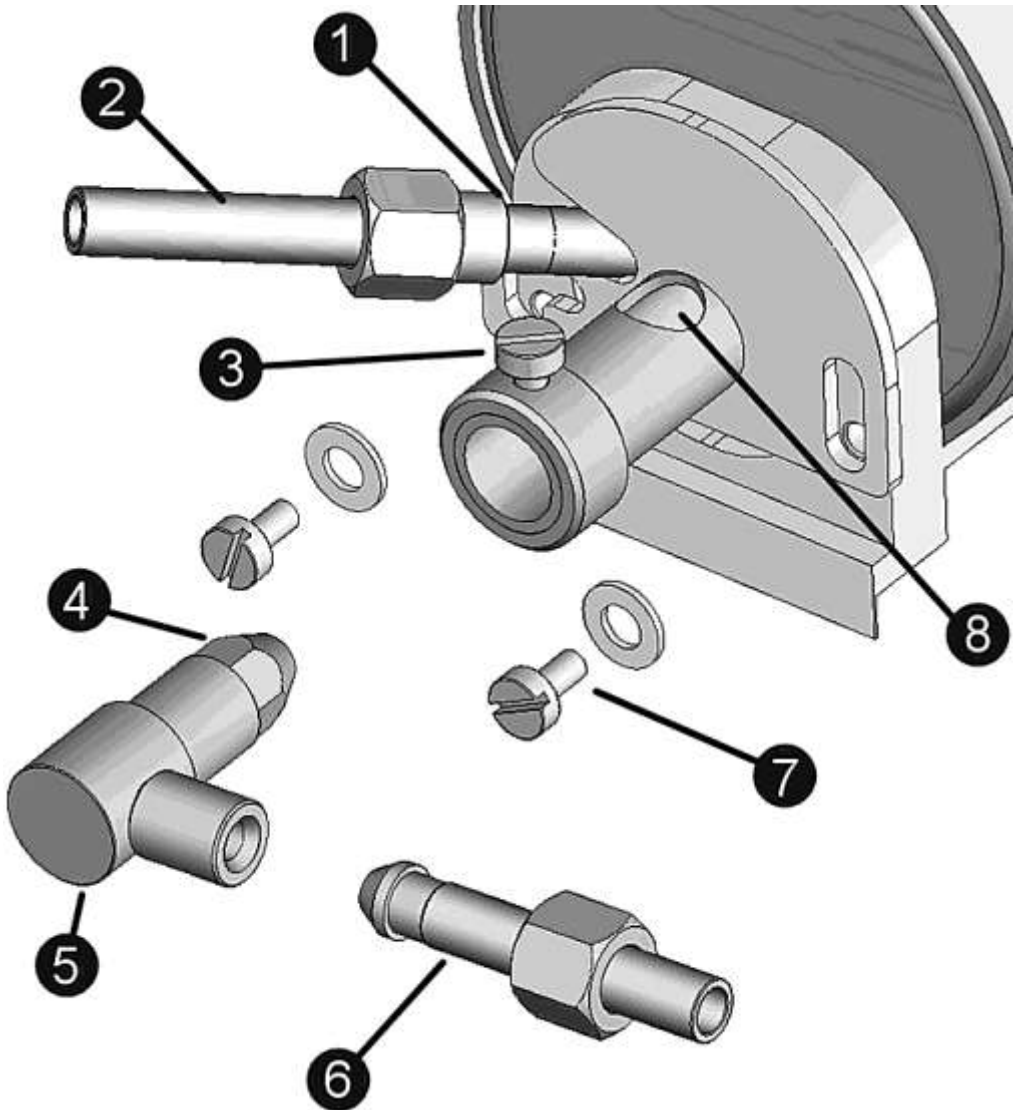

SERVICE AND PARTS

If any problems arise with this model which are not covered in these operating instructions or spare parts are required, owners should first contact their local dealer. Your **ROUNDHOUSE** dealer is;

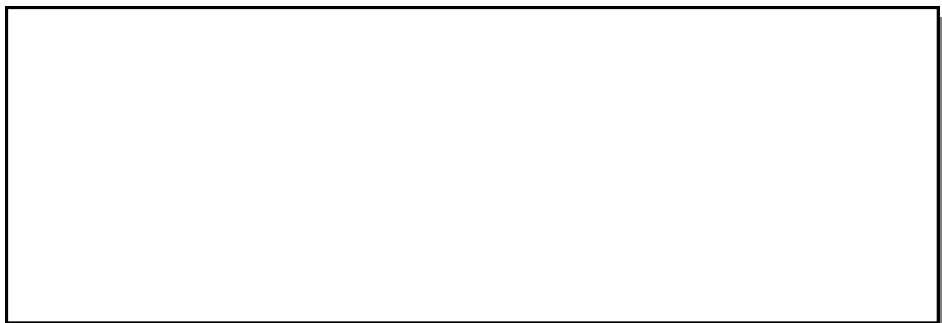

If your dealer is unable to help, please contact the Factory directly:

ROUNDHOUSE ENGINEERING CO. LTD.

Units 6-10 Churchill Business Park. Churchill Road.

Wheatley. Doncaster. DN1 2TF. England

Telephone: 01302 328035 Fax: 01302 761312

Email: mail@roundhouse-eng.com

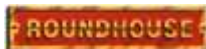

ONLINE

www.roundhouse-eng.com